

FOTRIC
CONNECTING THE DIGITAL FUTURE

Premium Thermal Camera

FOTRIC P *Series*



Cornerstones of a Premium Thermal Camera

Here in FOTRIC, We believe that achieving an exceptional level of performance in the following six aspects is essential for a premium camera.

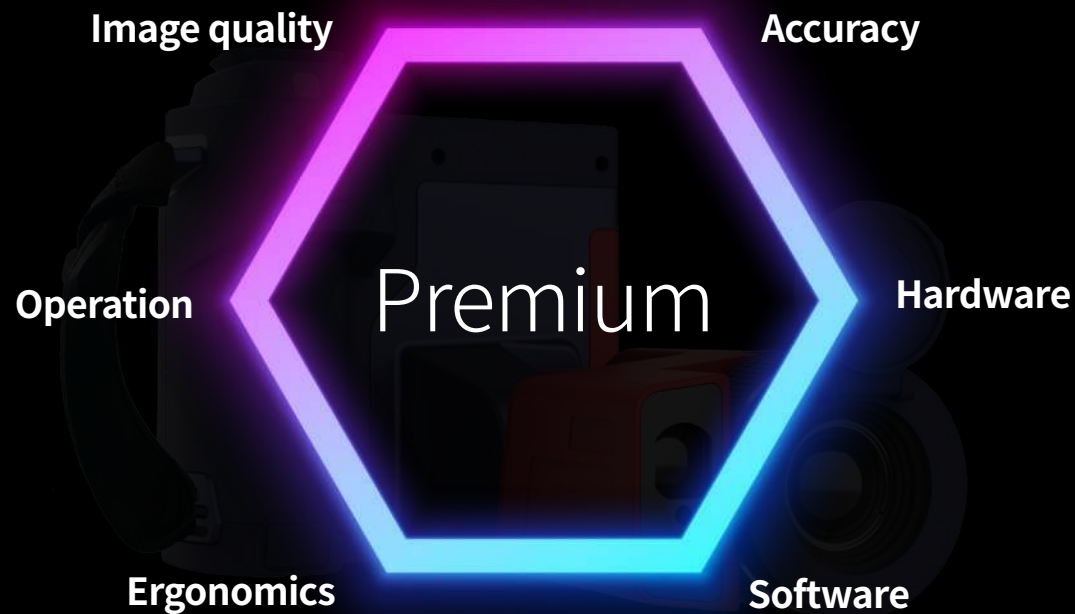

Compelling Image Quality -Hardware

Up to

1280*1024

IR resolution

Renders pristine image clarity and unlocks unparalleled precision for your inspection work

Covers

100% sRGB

Color gamut

LCD display accurately reproduces the entire sRGB color gamut, ensuring that it showcases the full extent of the camera's capabilities.



1280*1024 IR resolution (25° lens at 30m distance)



640*480 IR resolution (25° lens at 30m distance)

Compelling Image Quality -Firmware

TWB (thermal white balance) Feature

Magnifies subtle differences even at broad temperature range.

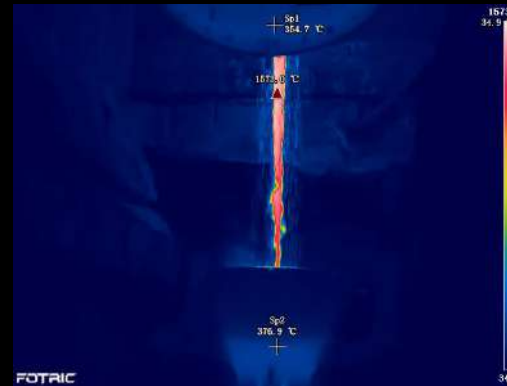

TWB OFF

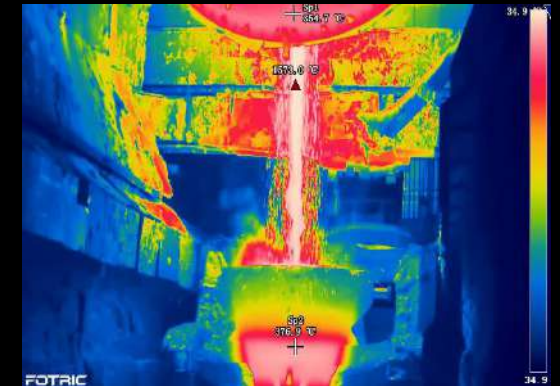

TWB ON

IREdge Imaging Algorithm

Optimize color pixel distribution to enhance image line prominence.



IREdge OFF



IREdge ON

Impeccable Accuracy

Reach

±1%

accuracy

Stay accurate at any ambient temperature

Up to

2000°C

temperature range

-20°C ~ 120°C , 0°C ~ 700°C
Extendable to -40°C and 2000°C

Up to

<1°C

image uniformity

Precise measurement throughout

Achieves

30mk

thermal sensitivity

Reveal the most subtle details



Meticulously Designed Hardware

Ergonomic Construct

Built-in 13 MP digital camera for dynamic image quality

0.5 inch OLED view finder

Laser ranger for accurate distance and area measurement

TurboFocus button

Bright LED lamps to illuminate the dark

Built-in 5 MP lens-side digital camera



AI programmable button

Built-in speaker for temperature alarm

5" HD LCD screen



Interchangeable lens on a 40-level rotary axis, provides the finest flexibility as well as stability

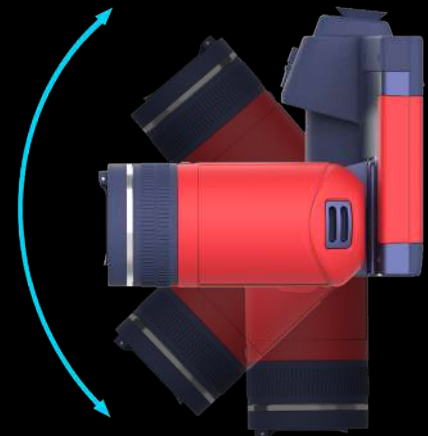

Meticulously Designed Hardware

One Lens to See them All

Eliminate the need to carry and change an extra lens, saving both your time and space



25° Lens

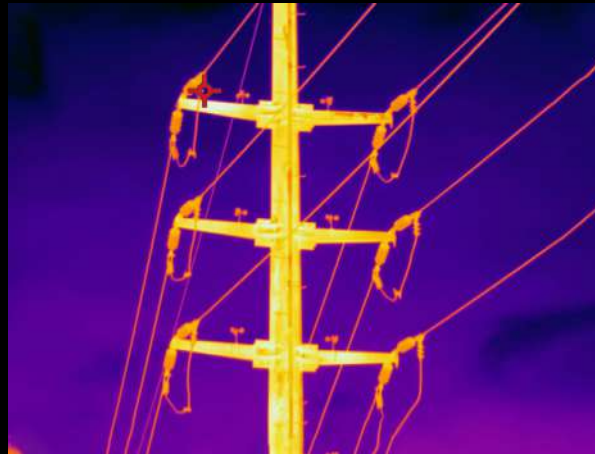

12° Lens



7° Lens

Meticulously Designed Hardware

A Wealth of Alternatives



44°
Wide-angle Lens



25°
Standard Lens



12°
Telephoto Lens



7°
Ultra Telephoto Lens



12° & 25°
Dual Field of View Lens



7° & 25°
Dual Field of View Lens

Extraordinary Operation Experience



Laser assisted area measurement

Laser-assisted measurement of area, height, and distance data.



Android platform

Interface movement stay fluid even with **1TB** max storage.



HawkAI

OCR instantly extract essential information during inspection.



One click favorite

Filtering key information from vast sea of thermal images.



Powerful software-NaviTiR

Revolutionizing routine inspection

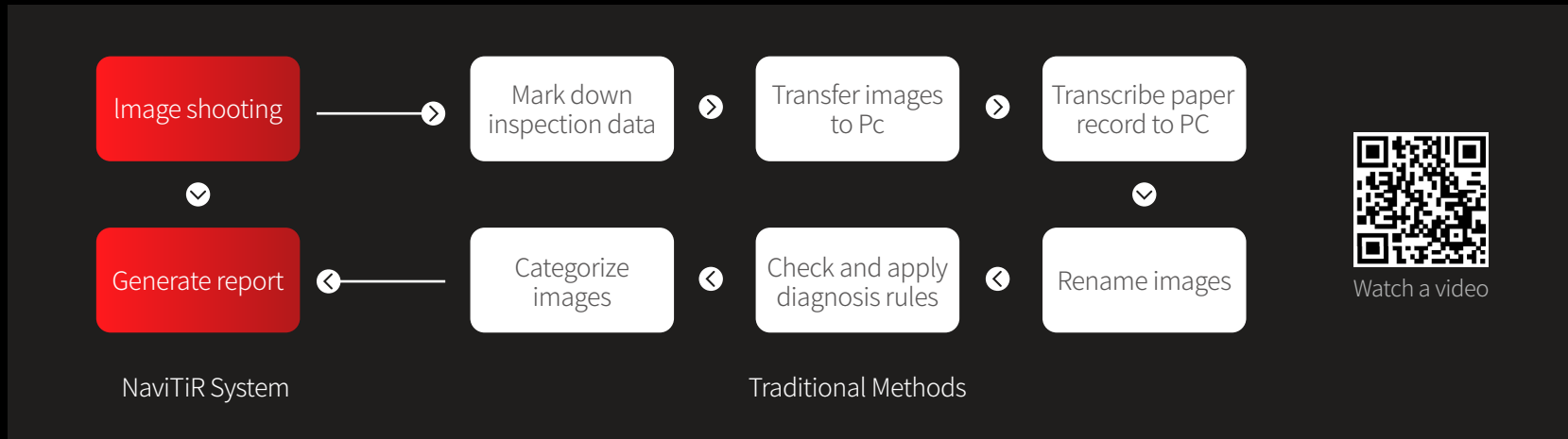



NaviTiR

Powerful software-NaviTiR

AI assistant at your hand

Object identification & Automatic diagnosis.



Traditional



NaviTiR - Object recognition



IRExplorer

Powerful software-IRExplorer

Brings untrammelled communication

- Remote control via WiFi  or Self-equipped Hotspot 
- No need for installation
- Across any platform  Windows  Linux  MacOS/iOS  Android
- Access and edit thermal files

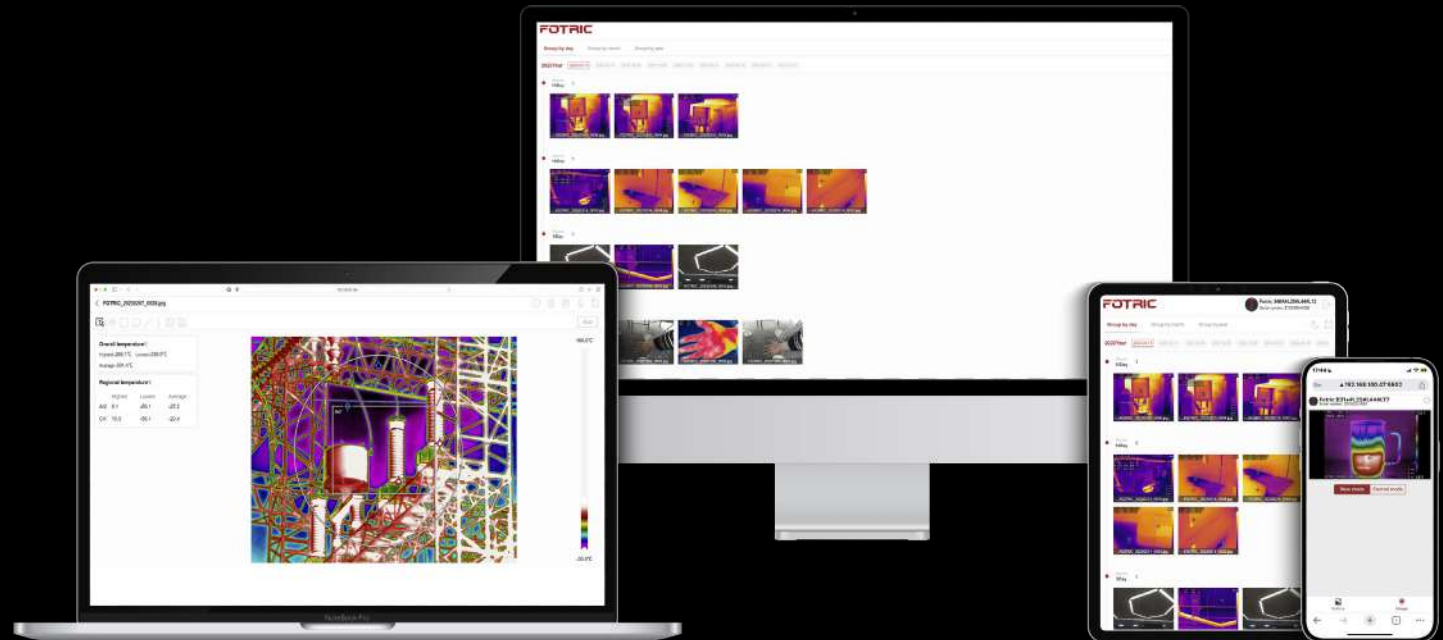

Specification

Model	FOTRIC P9	FOTRIC P8	FOTRIC P7	FOTRIC P6	FOTRIC P5	FOTRIC P4
Common Features						
Infrared Resolution	1280*1024	1024*768	640*480	480*360	384*288	320*240
Super Resolution (SR)	2560*2048	2048*1536	1280*960	960*720	768*576	640*480
Detector Type	Uncooled infrared focal plane detector					
Detector Pitch	12μm	12μm	17μm	17μm	17μm	17μm
Thermal Sensitivity (NETD)	20mk @ 30° C					
Infrared Spectral Band	7~14μm					
Frame Rate	30Hz					
Field of View (FOV)	25° x 19°					
IFOV with Standard Lens (spatial resolution)	0.34 mrad	0.43 mrad	0.68 mrad	0.91 mrad	1.14 mrad	1.36 mrad
Minimum Focus Distance	0.4m	0.4m	0.25 m	0.25 m	0.1 m	0.1m
Focal Lengths	f35	f35	f24.8	f24.8	f15	f15
Focus Mode	TurboFocus™ Speedy Intelligent Autofocus system for continuous, laser distance, graphic contrast, manual					
Lens Recognition	Auto					
Optional Lens	Refer to "Lens" Sheet Below					
Digital Zoom	1-32x	1-32x	1-16x	1-16x	1-12x	1-12x
Key Features						
NaviTiR	Optional					
NaviPdM	Optional					
T-DEF°	Support					
IREdge	Support					
T-TWB°	Support					

Temp Analysis						
Temperature Range	-20°C ~ 700°C					
Measurement Range	-20°C ~ 120°C, 0°C ~ 700°C					
Low/High Temperature Expansion (Optional)	Support extension: lowest to -40°C , highest to 2000°C			Support extension: lowest to -40°C , highest to 1550°C		
Intelligent in Temperature Range Adjustment	Support					
Accuracy	± 1°C or ± 1 %, whichever is greater (ambient temp at 25°C , temperature range 0° C-10° C), ± 2°C or ± 2 % when reach to 2000°C				± 2°C or ± 2 %, whichever is greater, (ambient temp at 25°C)	
User-definable Spot Markers (on device)	30 spot markers	30 spot markers	25 spot markers	20 spot markers	20 spot markers	20 spot markers
User-defined Measurement Boxes (on device)	30 (rectangle or circle)	30 (rectangle or circle)	25 (rectangle or circle)	20 (rectangle or circle)	20 (rectangle or circle)	20 (rectangle or circle)
User-defined Measurement Lines (on device)	30 measurement lines	30 measurement lines	25 measurement lines	20 measurement lines	20 measurement lines	20 measurement lines
User-definable ROI on PC software	Unlimited					
On-screen Analysis	Emissivity, Partially emissivity, Reflected temperature, Ambient temperature, Humidity, Distance and IR window compensation.					
On-Screen Temperature Test	Temp Rise Test, Temp Differentiation Test					
Sound Alarms	Area alarm; High temperature alarm and low temperature alarm					
Color Alarms (temperature alarms)	High temperature, low temperature, and interval isotherms					
PC Software	AnalyzeIR, NaviTIR					
Image Display						
Display	5inch (landscape)1280*720					
View-Finder (Optional)	0.5inch OLED, 800*600					
Image Mode	Thermal\Digital\Picture-in-Picture\T-DEF®					
Palettes	16 standard palettes: Grey、Iron10、Iron、Rainbow、Grey10、GreyRed、MidGrey、Yellow、Rain、Rain10、Blue、GlowBow、Medical、Medical10、MidGreen、Prism. 16 inverted palettes					
Temp Scale	Auto (Minimum Temp Span 3°C), Manual (Minimum Temp Span 2°C), Touch-screen(Minimum Temp Span 2°C)					

Highest/Lowest Temp Spot Mark	Yes,full-screen and measurement boxes both with highest/lowest temp spot marker					
Imaging Mode						
Digital Camera	5-mega pixel and 13-mega pixel					
Storage	SD card of 256GB memory, support expansion to 2TB	SD card of 256GB memory, support expansion to 2TB	SD card of 128GB memory, support expansion to 2TB	SD card of 128GB memory, support expansion to 2TB	SD card of 64GB memory, support expansion to 2TB	SD card of 64GB memory, support expansion to 2TB
Shooting Mode	Support on Single Frame Rate Capture and Timing Capture					
Image/video File Formats	Standard JPEG full radiometric thermal images, digital images, .IRS full radiometric thermal videos, .MP4 non-radiometric videos					
Image Freezing	Support on Single Frame Rate thermal imager and full-radiometric video					
Scan Function	Support for QR code and Barcode					
Annotation	Support Voice\Text\Bookmark\Favorite					
Analyze Radiometric Image Data (On-screen)	Support					
Analyze Radiometric Video Data (On-screen)	Support					
Non-Radiometric Video	Support					
Gallery	Image preview and analyze, video preview and analyze					
Data Connectivity						
WiFi Connection	Support 2.4GHz and 5 GHz frequency, support 802.11a/b/g/n/ac					
Bluetooth Connection	BT4.2 LE, connectable to bluetooth headphone					
USB Interface	USB type-C type; conforms to USB 3.0 / 2.0 specification, supports USB OTG; USB 3.0 has a maximum speed of 5Gbps; USB 2.0 supports a maximum speed of 480Mbps, and is downward compatible with full speed (12Mbps) mode					
HDMI Interface	Micro HDMI type,Comply with HDMI 1.4 specification, support 1080p image video transmission at 60Hz frame rate					
FTP Data Transfer	Accessible through WiFi or Hotspot, rapid data transfer					
Remote Control	Support					
EasyIR APP	Support					
IRExplorer	Support					
General Specifications						
Software Upgrade	Support on OTA upgrade and local upgrade through USB					

Laser Ranger/Pointer	Independent key activation; Laser level: 2; Wavelength: 635nm; Power: <1mW; Laser distance: 0.1~50m, Accuracy: d*0.01%±2mm
Laser Measurement	Distance, Length, and Area
LED Light (torch and flash lamp)	Support
Battery	
Battery Type	3.6V, 10000mAh lithium
Battery Life	Over 4 hours per battery
Battery Charging System	Battery charger, DC 13V charging, USB charging
Battery Charging Time	2.5 hours to 90% full charge
Power Saving	User-selectable screen-off modes
AC Operation	AC operation with included power supply (100V ac -240V ac, 50/60Hz)
Reliability Test	
Safety	EN 62368-1:2014+A11:2017 (Power Supply)
Electromagnetic Compatibility	EN 61326-1:2013 (immunity) EN 61326-1:2013 Class A (emission) FCC 47 CFR Part15 Class A (emission)
Shock	25g(GB/T 2423.5-2019/IEC60068-2-27:2008)
Vibration	2g (GB/T 2423.10-2008/IEC 60068-2-6:1995)
Enclosure Rating	IP54
RoHS	Yes
Operating Temperature	-20°C to +50°C (-4 °F to 122 °F)
Storage Temperature	-40°C to +70°C (-40 °F ~158 °F) without battery
Relative Humidity	< 95%RH
Size (H x W x L)	175*151*95mm
Weight (withouth lens)	1.3kg
Hard Case	Hard rubber: PC + ABS, Soft rubber: TPE,Magnesium alloy, Flame retardant grade: UL94 HB
Tripod	UNC ¼"-20 interface
Warranty	2 years (standard), extended warranties are available,10 years for core detector
Recommended Calibration Cycle	2 years (assumes normal operation and normal aging)
Supported Languages	English, Spanish, France, Germany, Italian, Korea

Lens

Model	IR Resolution	Lens	Standard Lens	Wide-angle Lens	Telephoto Lens	Ultra Telephoto Lens	Dual-View Lens	
P9	1280*1024	FOV	25° x 20°					
		IFOV	0.34 mrad					
		Minimum Distance	0.4 m					
		Focal Length	35 mm					
P8	1024*768	FOV	25° x 19°					
		IFOV	0.43 mrad					
		Minimum Distance	0.4 m					
		Focal Length	35 mm					
P7	640*480	FOV	25° x 19°	46° x 35°	12° x 9°	7° x 5°	25° x 19° \ 12° x 9°	25° x 19° \ 7° x 5°
		IFOV	0.68 mrad	1.25 mrad	0.33 mrad	0.19 mrad	0.68 mrad \ 0.33 mrad	0.68 mrad \ 0.19 mrad
		Minimum Distance	0.25 m	0.1 m	1 m	3 m	0.25 m \ 1 m	0.25 m \ 3 m
		Focal Length	24.8 mm	13.7 mm	51.2 mm	82.5 mm	25.1 mm \ 50.7 mm	25.4 mm \ 76.8 mm
P6	480*360	FOV	25° x 19°	46° x 35°	12° x 9°	7° x 5°	25° x 19° \ 12° x 9°	25° x 19° \ 7° x 5°
		IFOV	0.91 mrad	1.67 mrad	0.44 mrad	0.25 mrad	0.85 mrad \ 0.44 mrad	0.85 mrad \ 0.25 mrad
		Minimum Distance	0.25 m	0.1 m	1 m	3 m	0.25 m \ 1 m	0.25 m \ 3 m
		Focal Length	24.8 mm	13.7 mm	51.2 mm	82.5 mm	25.1 mm \ 50.7 mm	25.4 mm \ 76.8 mm
P5	384*288	FOV	25° x 19°	46° x 35°	15° x 11°	7° x 5°		
		IFOV	1.14 mrad	2.09 mrad	0.68 mrd	0.32 mrad		
		Minimum Distance	0.1 m	0.1 m	0.25 m	1 m		
		Focal Length	15 mm	8 mm	24.8 mm	51.2 mm		
P4	320*240	FOV	25° x 19°	46° x 35°	15° x 11°	7° x 5°		
		IFOV	1.36 mrad	2.51 mrad	0.82 mrd	0.38 mrad		
		Minimum Distance	0.1 m	0.1 m	0.25 m	1 m		
		Focal Length	15 mm	8 mm	24.8 mm	51.2 mm		

Innovation Excellence Integrity

FOTRIC INC. All Rights reserved

April 2023

www.fotric.com

FOTRIC
CONNECTING THE DIGITAL FUTURE